

Preliminary

PO-TS3020YCN-004

1. SPECIFICATIONS

(1) Absolute Maximum Ratings

(Ta=25°C)

Parameter	Symbol	MAX.	Unit
Continuous Forward Current	If	20	mA
Pulse Forward Current*	Ifp	100	mA
Reverse Voltage	Vr	5	V
Power Consumption	Pc	55	mW
Operating Temperature Range	Topr	-40 ~ +85	°C
Storage Temperature Range	Tstg	-40 ~ +100	°C
Electrostatic Discharge	ESD	2000	V
Soldering Temperature	Tsld	Reflow Soldering:240°C/10sec Hand Soldering:350°C/3sec	

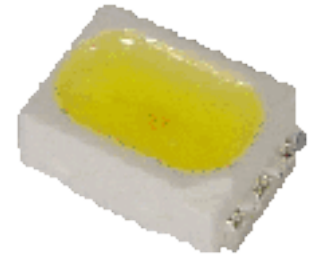

*Duty 1/10 @ 1KHZ

(2) Electrical / Optical Characteristics

(Ta=25°C)

Parameter	Symbol	Min.	Typ.	Max.	Unit	Test Condition
Forward Voltage*	Vf	1.8	/	2.8	V	If=20mA
Luminous intensity*	Iv	100	155	/	mcd	If=20mA
Dominant Wavelength	λ_d	/	590	/	nm	If=20mA
Spectrum Radiation Bandwidth	$\Delta\lambda$	20	25	30	nm	If=20mA
Reverse Current	Ir	/	/	10	μ A	VR=5V
Viewing Angle	2 θ 1/2	/	120	/	Deg	*

*Forward voltage measurement allowance is $\pm 0.1V$.

*Luminous intensity is measured with a light sensor and filter combination that approximates the CIE eye-response curve.

*Luminous Intensity Measurement Allowance is $\pm 10\%$.

*Dominant Wavelength measurement allowance is $\pm 1nm$.

*2 θ 1/2 is the off-axis angle at which the luminous intensity is half the axial luminous intensity.

*Please see attachments for BIN classifications.

(3) Typical Electrical / Optical Characteristics Curves

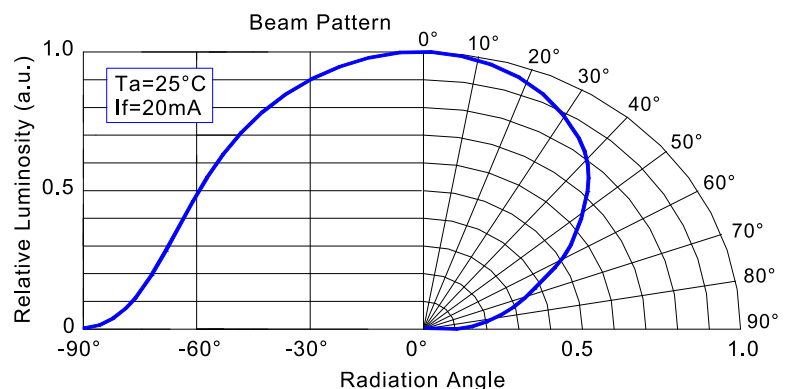
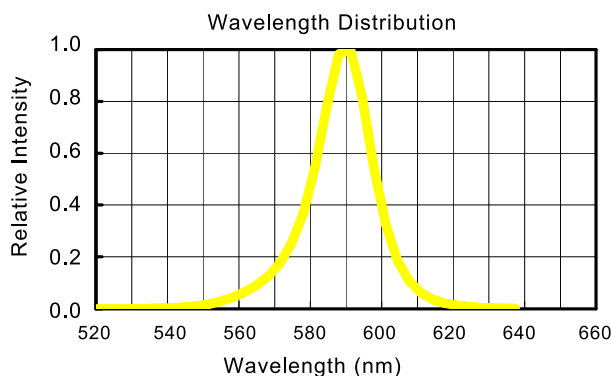

2. Package

(1) Outline Dimension

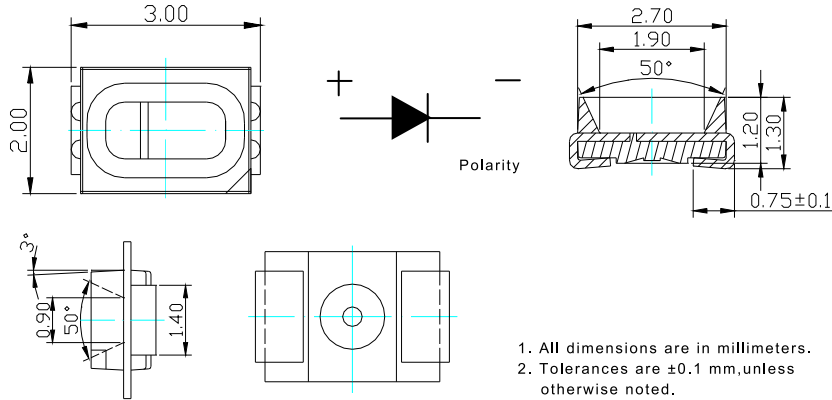

(2) Taping Dimension (unit= mm)

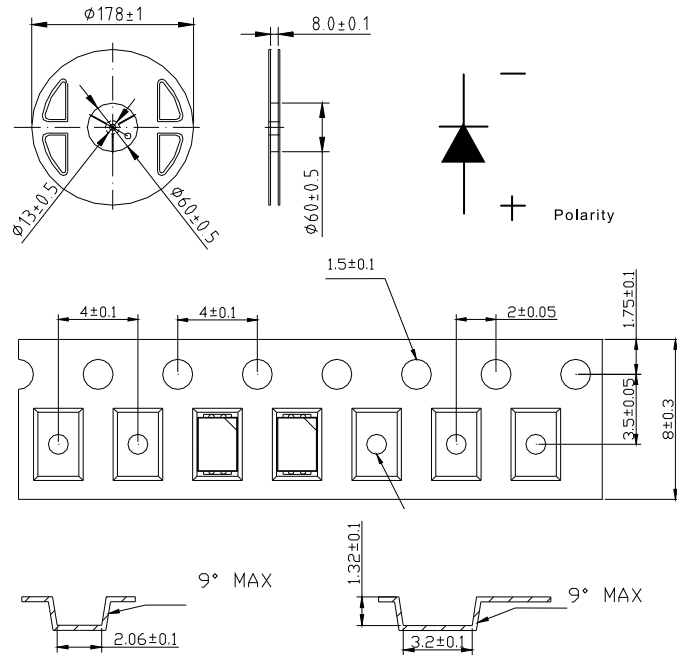

3. Handling Precaution

(1) Recommended soldering conditions

1.1 Reflow solder temperature profile

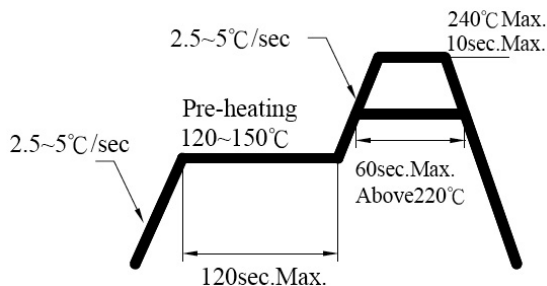

1.2 Recommended Soldering pad design (unit= mm)

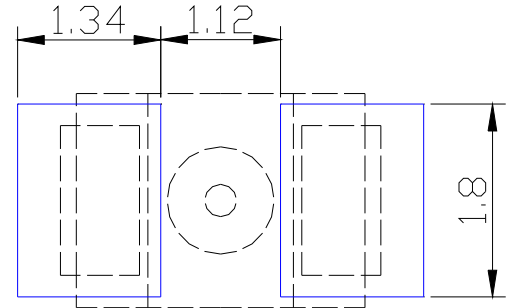

1.3 Soldering conditions

- Reflow soldering should not be done more than twice.
- When soldering, do not stress on LEDs during heating.
- After soldering, do not warp the circuit board.

(2) Repairing

- Repair should not be done after the LEDs have been soldered. When repair is unavoidable, double-head soldering iron should be used. It should be confirmed beforehand whether the characteristics of the LEDs will be damaged by repair or not.

(3) Cleaning

- It is recommended to use isopropyl alcohol as a solvent to clean the LEDs. When using other solvents, it should be confirmed beforehand whether the solvents will dissolve the package and the resin or not.

(4) Advice on Device Usage

- It is recommended that user should complete the use of the whole package within 8 hours upon unsealing. In the event of incomplete usage, it is advised that user preheat the remaining devices at 60°C for 8 hours prior to use.